

| CONSUMOS MEIOS | | |
|-------------------------|------------|--|
| ESPECIFICAÇÃO | < 0,10m³/m | |
| CONCRETO fck 15 MPa | 0,103m³/m | |
| FORMAS DE MADEIRA COMUM | 0,710m²/m | |

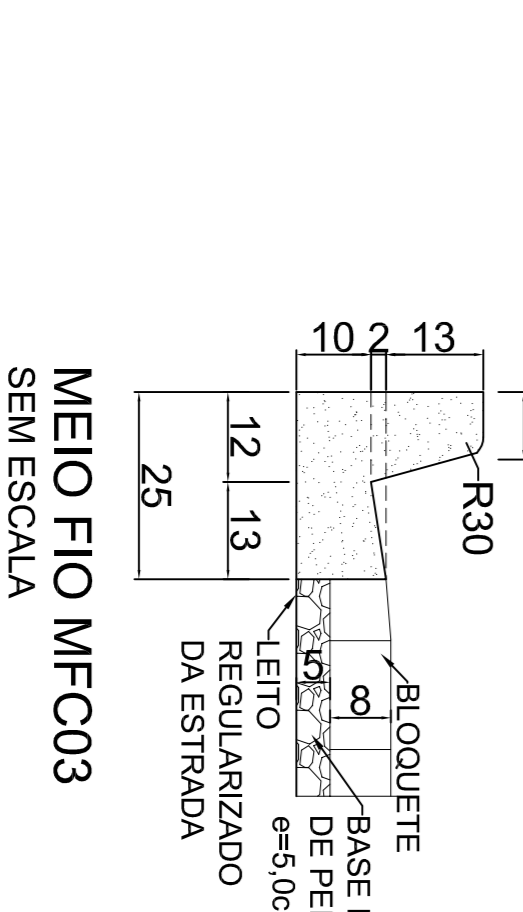

| ÁREA TOTAL DE PAVIMENTAÇÃO | ÁREA DE REGULARIZAÇÃO | TRAVAMENTO COMP. (m) | ARMAÇÃO DE Ø8.0mm COMP. (m) | PESO(kg) | FORMA | VOLUME DE | COMP. SARETA | COMP. SARETA | Ø400mm | CAIXAS | MEIO-FIO PRE MOLDADO | MEIO-FIO MFC 01 | MEIO-FIO MFC 03 | DISSIPADOR |
|----------------------------|-----------------------|----------------------|-----------------------------|----------|--------|-----------|--------------|--------------|--------|--------|----------------------|-----------------|-----------------|------------|
| 729,78 | 808,84 | 26,00 | 104,00 | 41,08 | 15,80 | 1,56 | 121,63 | 121,63 | 0,00 | 0,00 | 121,63 | 121,63 | 0,00 | 0,00 |
| TRECHO 1 | 608,70 | 36,71 | 146,84 | 58,00 | 22,03 | 2,20 | 101,45 | 101,45 | 0,00 | 0,00 | 101,45 | 101,45 | 0,00 | 0,00 |
| TRECHO 2 | 828,32 | 913,90 | 16,61 | 66,44 | 13,64 | 1,00 | 276,60 | 276,60 | 16,00 | 4,00 | 276,60 | 276,60 | 6,00 | 6,00 |
| TRECHO 3 | 960,06 | 1040,07 | 30,18 | 120,72 | 47,68 | 1,81 | 320,02 | 320,02 | 33,00 | 5,00 | 320,02 | 320,02 | 6,00 | 6,00 |
| TRECHO 4 | 3126,86 | 3437,45 | 109,50 | 438,00 | 173,01 | 6,57 | 819,70 | 819,70 | 49,00 | 9,00 | 223,08 | 223,08 | 596,62 | 12,00 |

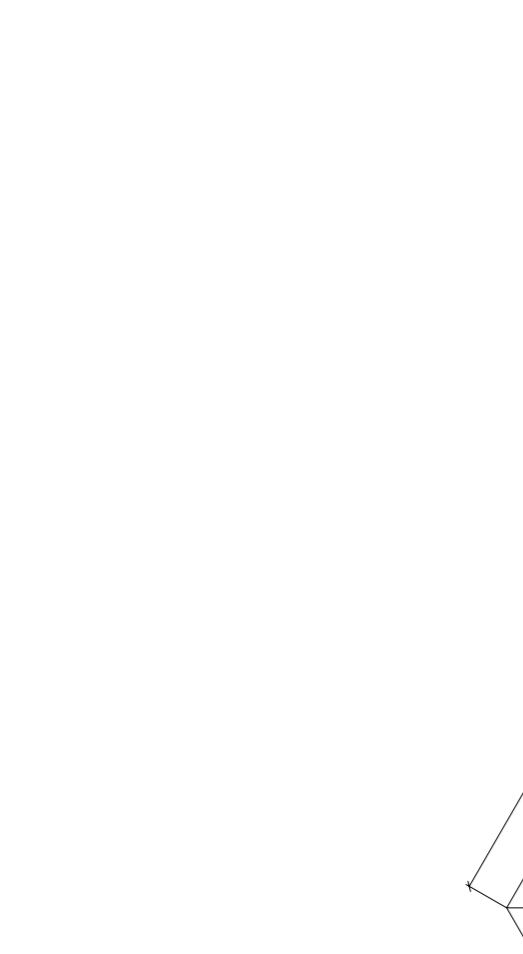
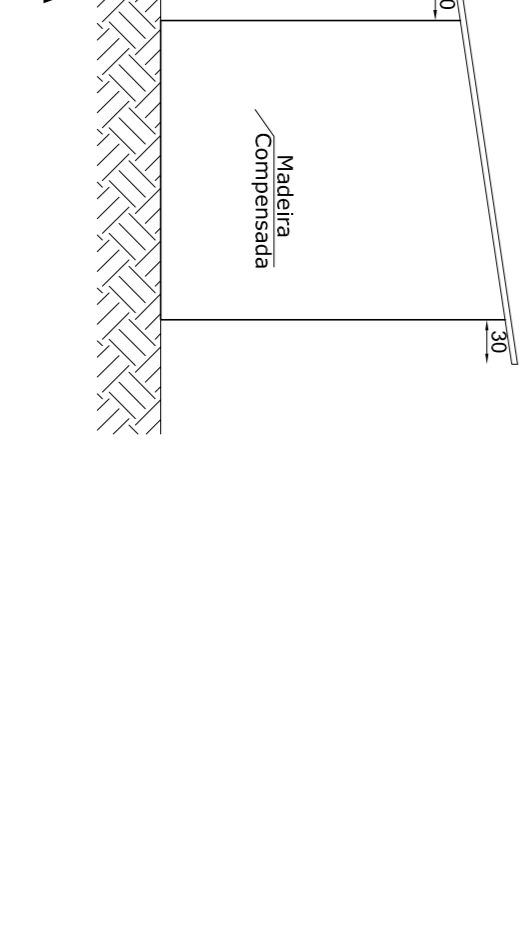
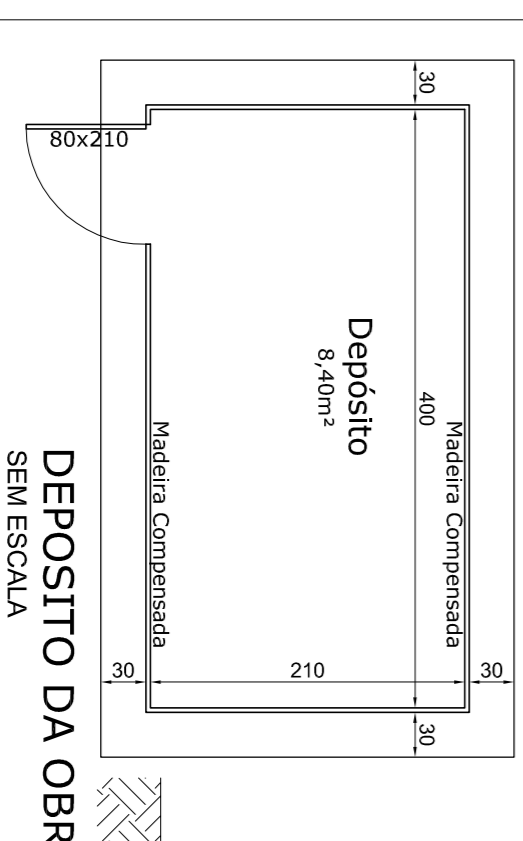
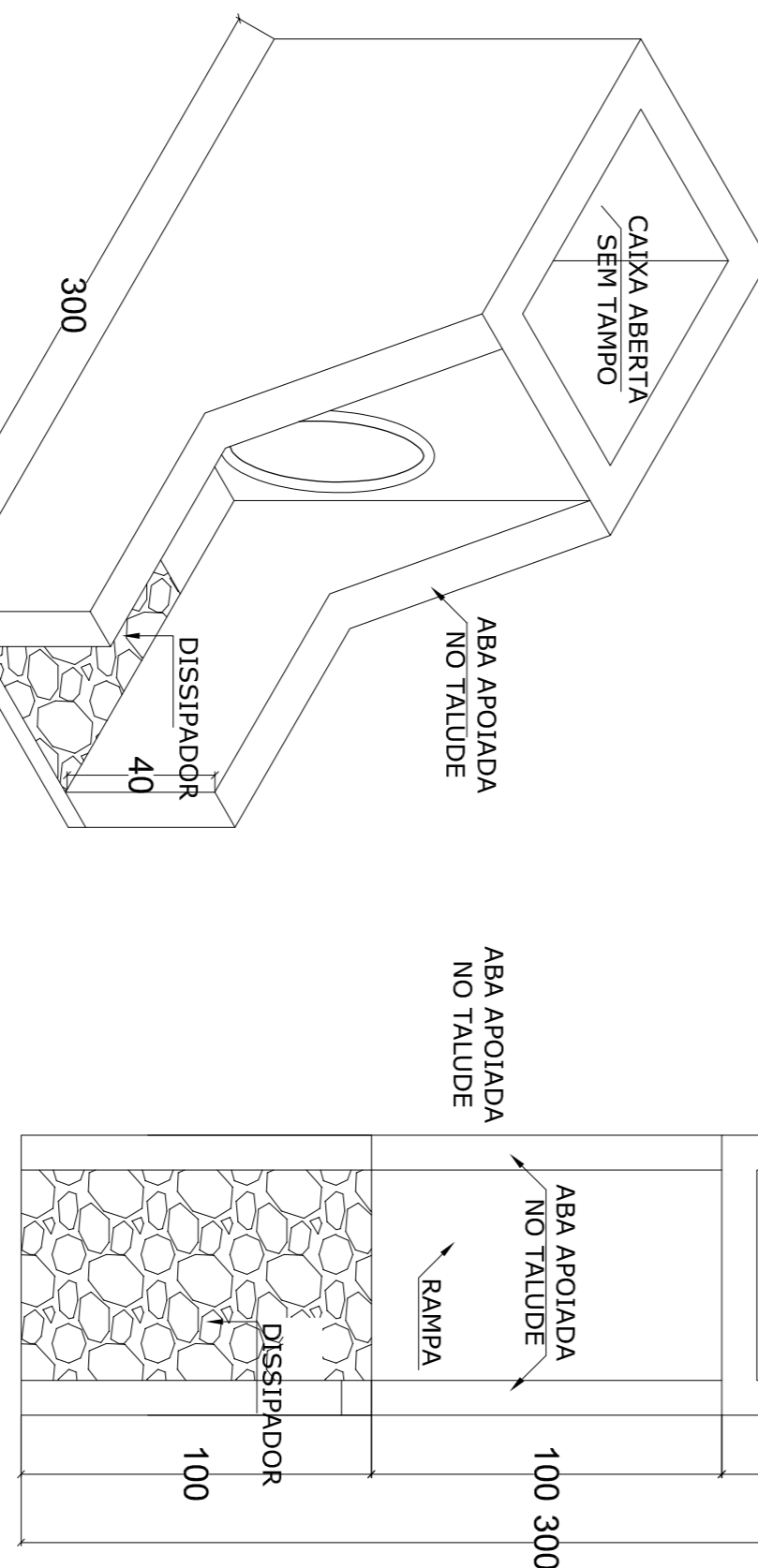
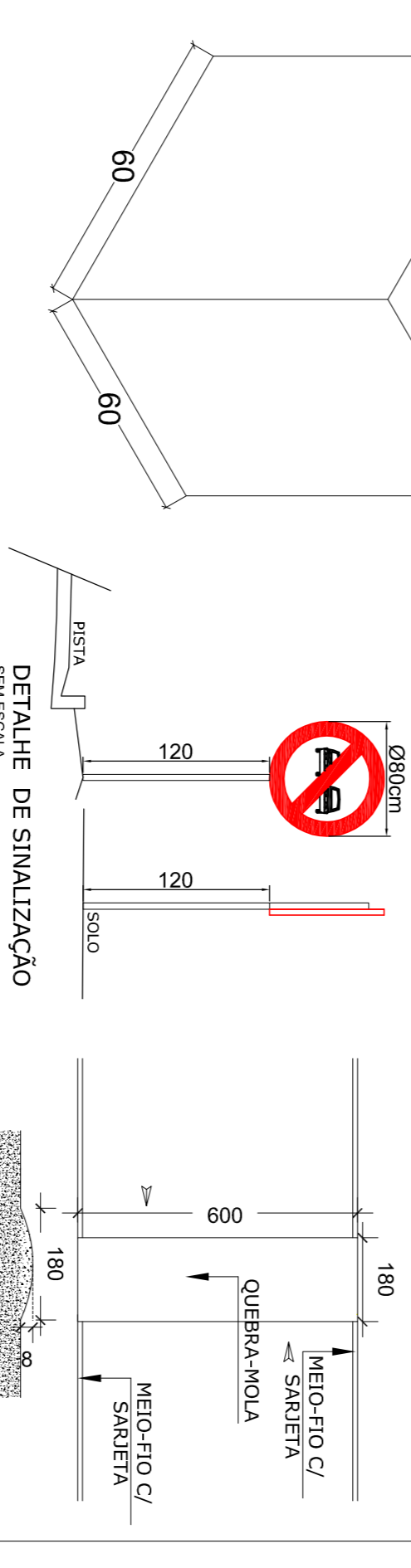
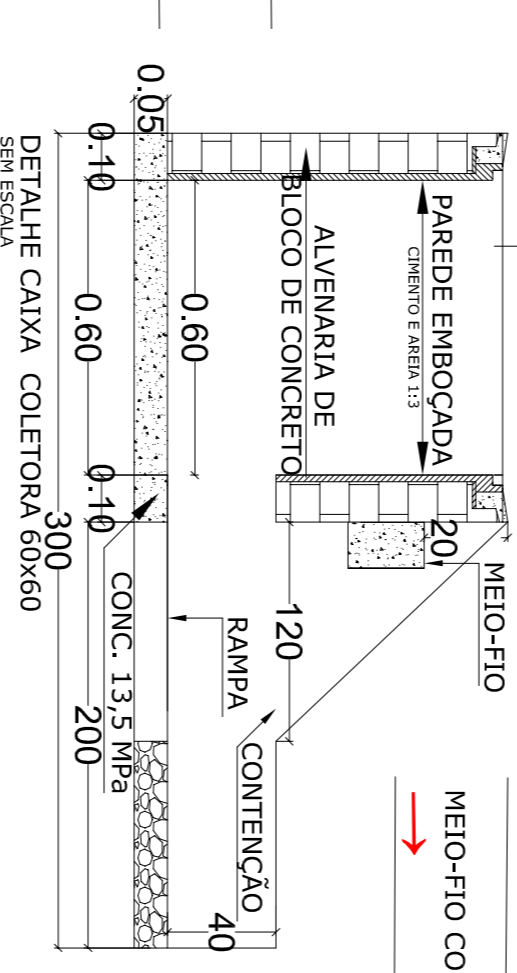
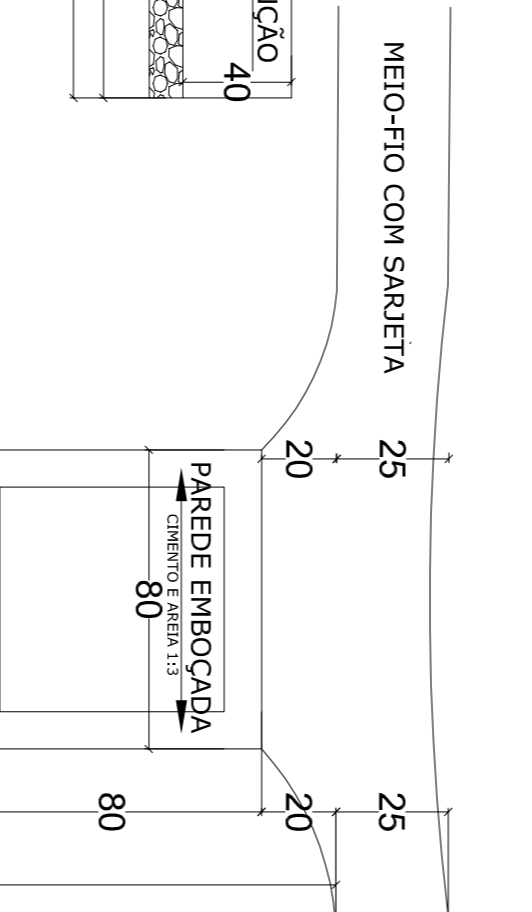
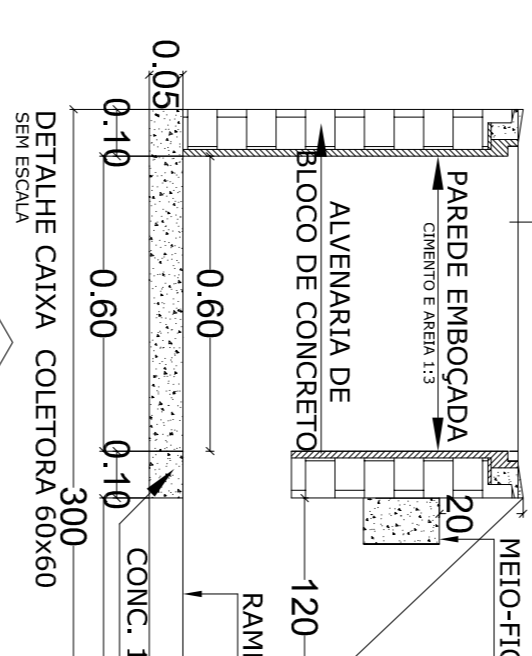
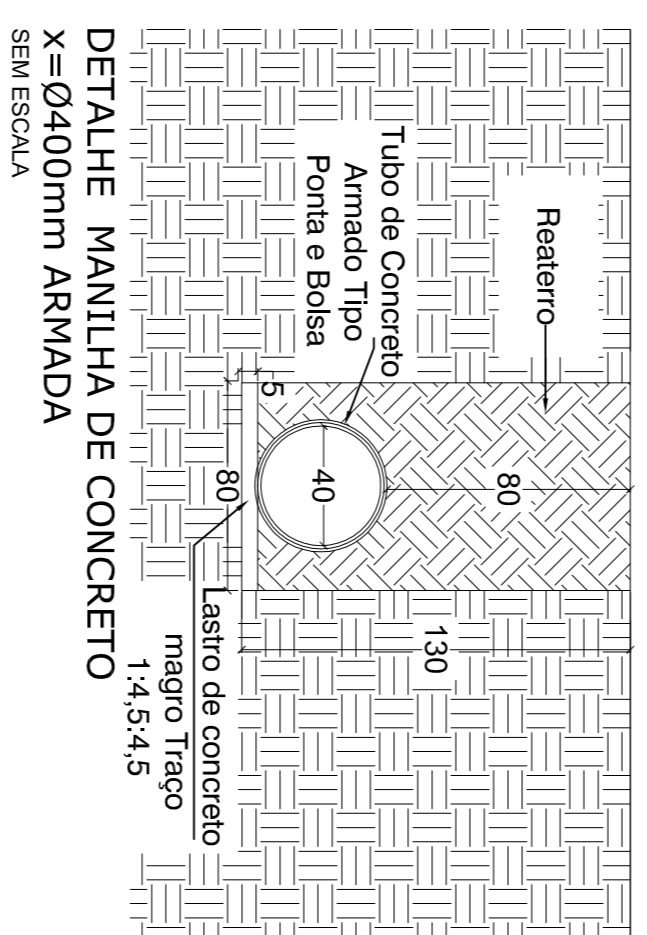
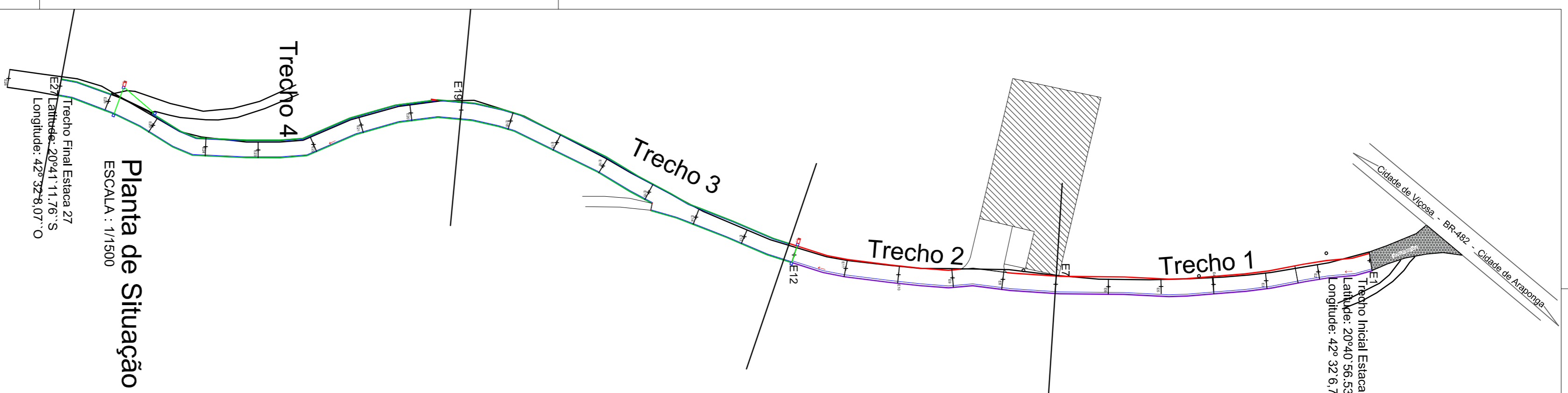
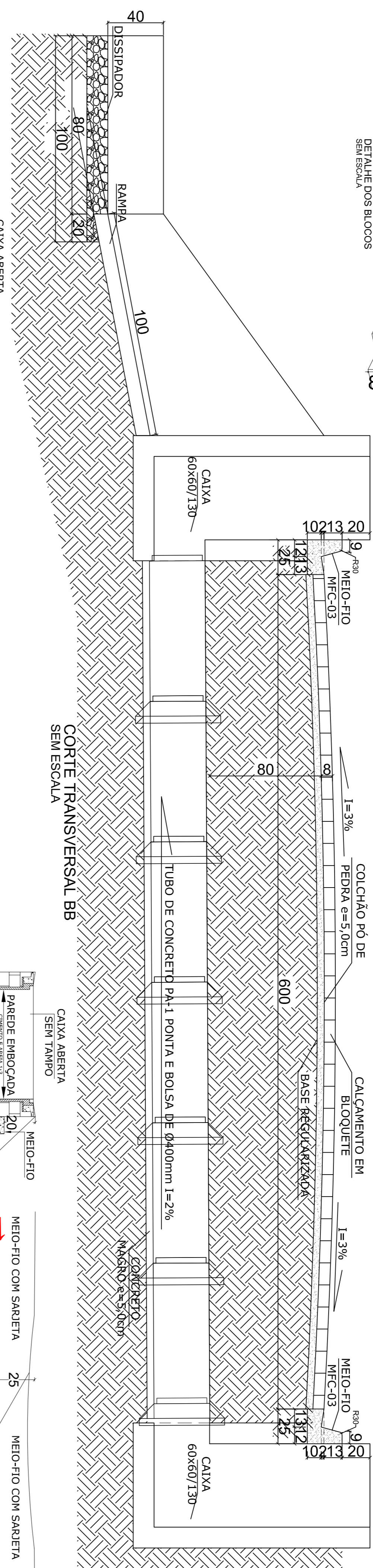
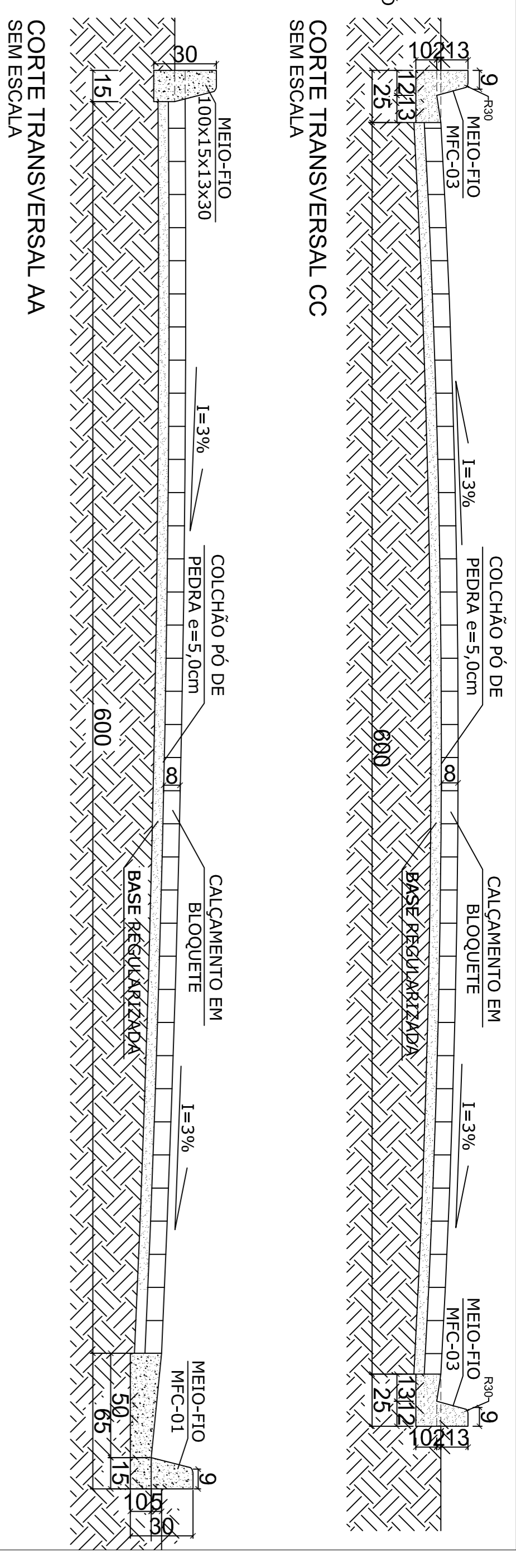
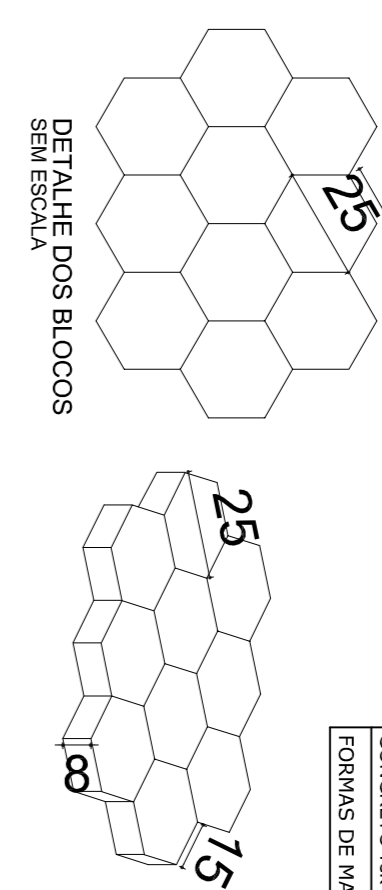
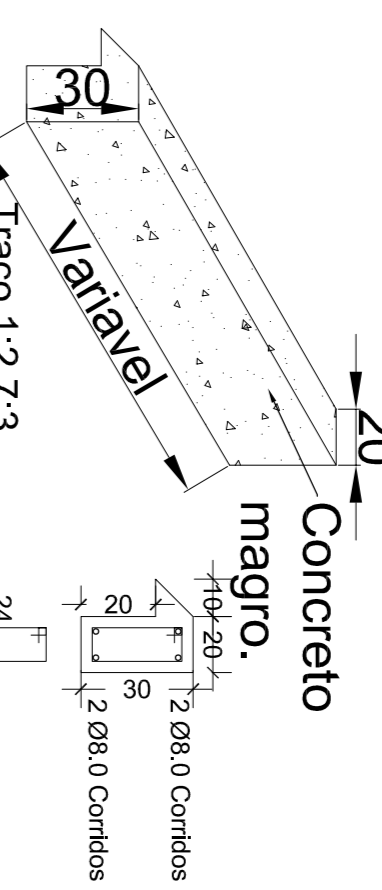
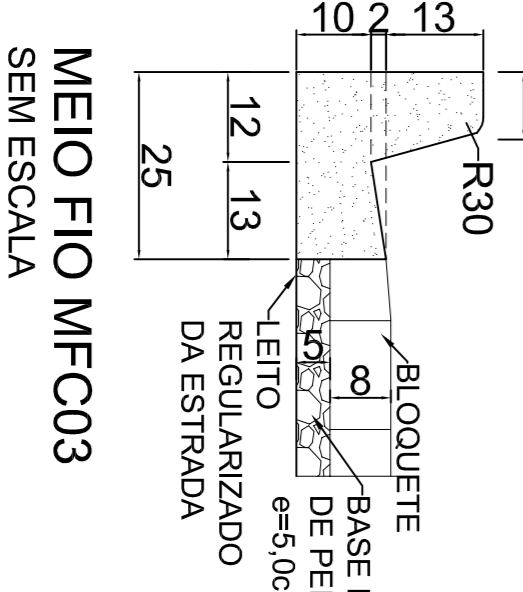

| LEGENDA | |
|---------|-------------------------------|
| | MEIO-FIO PRÉ-MOLDADO |
| | MEIO-FIO MFC 01 |
| | MEIO-FIO MFC 03 |
| | SARETA |
| | REDE DE ESGOTO Ø400mm |
| | LEITO DA ESTRADA EXISTENTE |
| | PAVIMENTAÇÃO EM BLOQUETE |
| | RAMPAS DE DISSIPAÇÃO |
| | CAIXAS DE DRENAGEM |
| | SENTIDO DO ESCOAMENTO DE ÁGUA |

VERSIÃO: 001
DATA: 11/09/2023
VERIFICAÇÃO: JOBER DE QUEIJEIRA FERNANDES
PROJETO: 148
RESPONSÁVEL TÉCNICO: JOBER DE QUEIJEIRA FERNANDES

TÍTULO: Pavimentação com piso intertravado em bloquete na Estrada da Vicinal - Alto da Bucaina- Araponga-MG
CLIENTE: Prefeitura Municipal de Araponga
RESPONSÁVEL: Jobber de Oliveira Fernandes
ENGENHEIRO: Douglas Eduardo
PROJETO: PAV-2111102021
ENGENHEIRO: Douglas Eduardo
PROJETO: PAV-2111102021
ENGENHEIRO: Douglas Eduardo

Zona Rural da Comunidade da Bucaina, Araponga - MG

PROJETO: Nº 942397/2023
PROPOSTA: Nº 01/03
DATA: 01/10/23